

Big Green Egg® PRODUCT CATALOGUE



Please Note: The products shown in this catalogue are representative of various items that Big Green Egg makes available throughout the year – not all dealers stock every item, so if you cannot locate an item please contact Big Green Egg Customer Service for assistance.

Big Green Egg®



XXL XLARGE

- Grid Diameter: 29 in / 74 cm
- Cooking Area: 672 sq in / 4336 sq cm
- Weight: 424 lbs / 192 kgs

XL XLARGE

- Grid Diameter: 24 in / 61 cm
- Cooking Area: 452 sq in / 2919 sq cm
- Weight: 219 lbs / 99 kgs

L LARGE

- Grid Diameter: 18.25 in / 46 cm
- Cooking Area: 262 sq in / 1688 sq cm
- Weight: 162 lbs / 73 kgs

M MEDIUM

- Grid Diameter: 15 in / 38 cm
- Cooking Area: 177 sq in / 1140 sq cm
- Weight: 114 lbs / 52 kgs

> **The Big Green Egg stands alone as the most versatile barbecue and outdoor cooking product on the market, with more capabilities than all other conventional cookers combined. From appetizers to entrees to desserts, the Big Green Egg will exceed all your expectations for culinary perfection ... and with seven convenient sizes to choose from, there is a Big Green Egg to fit any need and lifestyle!**

XXLARGE

The Biggest Green Egg of them all, the unrivaled XXLarge can easily handle your family reunion or cookouts with large groups – and is more than large enough to satisfy restaurant and catering needs. You'll need to gather a crowd to tackle all of the ribs, steaks and burgers this EGG can handle ... all at once! You can even roast a suckling pig ... explore all the culinary possibilities with the ultimate XXL!

XLARGE

The hardworking XLarge EGG provides a cooking area that can easily accommodate meals for large families and cookouts with all your friends – and you can efficiently prepare several meals over the coals at once. Ready to serve up twelve racks of ribs, twenty-four burgers or a couple of holiday turkeys with all the trimmings? No problem!

LARGE

The Large EGG is the most popular size and a favorite to handle the cooking needs of most families and gatherings of friends. Accommodates a complete array of EGGcessories for grilling, baking, roasting or smoking – and is versatile enough for weekend cookouts and pizza parties, large enough for eight steaks at once, and efficient enough for an impressive meatloaf dinner for two!



LEARN MORE ABOUT EGG SIZES



S SMALL

- Grid Diameter: 13 in / 33 cm
- Cooking Area: 133 sq in / 856 sq cm
- Weight: 80 lbs / 36 kgs



MX MINIMAX

- Grid Diameter: 13 in / 33 cm
- Cooking Area: 133 sq in / 856 sq cm
- Weight: 76 lbs / 35 kgs



MN MINI

- Grid Diameter: 10 in / 25 cm
- Cooking Area: 79 sq in / 507 sq cm
- Weight: 39 lbs / 18 kgs

MEDIUM

Big flavor in a compact package! The Medium EGG is perfectly sized for smaller families and couples, and accommodates all the most popular EGGcessories. Get the famous Big Green Egg versatility and efficiency with plenty of cooking area to handle a backyard cookout of four large steaks or two whole chickens.

SMALL

The Small EGG is a great fit for smaller patios and balconies, and is often used as an addition to a larger EGG to allow the preparation of several courses at once. It's perfect for restaurants seeking the performance of an EGG in a size to fit a commercial kitchen.

MINIMAX™

A popular backyard staple and an invaluable culinary tool for restaurant chefs, the MiniMaxEGG® is designed with the height of a Mini yet all the volume capabilities of a Small. MiniMax comes with an easy to grip Carrier, so it's perfect as a table-side cooker at your garden party or a traveling EGG for motorhomes or tailgating.

MINI

A Mini EGG is the perfect portable solution for picnics and occasions when you want to take The Ultimate Cooking Experience with you! It is also a popular size for grilling on apartment balconies, vacations, boating and campfire meals – as well as a popular fixture in many commercial kitchens. Big results in a Mini package!



100% Natural Oak and Hickory Lump Charcoal

Our superior natural lump charcoal is made from 100% oak and hickory wood and contains no by-products, chemical fillers or petroleum additives. Natural lump charcoal imparts a great flavor to foods with no chemical aftertaste ... you will see – and taste – the difference immediately.

Natural Lump Charcoal

20 lb / 9 kg bag – 390011

Natural Lump Charcoal

10 lb / 4.5 kg bag – 110503

Charcoal Starters

Lighting charcoal is a breeze with our three recommended starters.



SpeediLight® Natural Charcoal Starters

Our SpeediLight Natural Charcoal Starters light easily and are odorless and tasteless, with no chemical aromas or residue. Plus, they're clean, safe and ready to use without the need for any lighter fluid. Box of 24 squares – 101020



EGGniter® Electric Charcoal Igniter

This genuine Big Green Egg Electric charcoal igniter is quick, easy and convenient – the EGGniter ignites lump charcoal or hardwood in just minutes without striking a match ... by using only super-heated air! 120V/1500W – 117540



Electric Charcoal Starter

If you prefer ignition at the click of a finger, then switch on our Electric Starter. This handy device, with a heat resistant handle, will have you cooking in minutes without even striking a match! – 101013

Build your outdoor kitchen one step at a time with the Big Green Egg Modular Nest System!

Start with an EGG Frame, then add to your custom EGG display with Expansion Frames and a variety of beautiful and functional inserts. You won't believe all of the possibilities!

EGG Frames

EGG Frames include one EGG Frame, stainless steel grid insert and tool hook. Levelers included, optional casters available.

For XLarge EGG – 120229
For Large EGG – 120212



120212



Modular Nest Inserts

Distressed Acacia Wood Insert – 120267
Acacia Wood Insert – 120250

Solid Stainless Steel Insert – 120274
Stainless Steel Grid Insert – 120243



Expansion Frame

Includes one Connector Pack to secure the Expansion Frame to the EGG Frame. Add a combination of beautiful inserts to customize your outdoor cooking area – 120236



BBQ Tool Hooks

Solid stainless steel hooks can be added to any side of the Modular Nest Frame. Also includes wood screws so you can add extra tool storage to any wooden table – 120281



120410

114662

Locking Caster Kits

For easy mobility, add a set of casters to your Big Green Egg Hardwood Table or Modular Nest.

4 in / 10 cm Caster Kit – 120410
Set of 2, with 1 locking caster

2 in / 5 cm Caster Kit – 114662
Set of 4, with 2 locking casters

Designed and engineered to work perfectly with your Big Green Egg for years of enjoyment!

Custom Cooking Islands

The 76 in / 1.9 m Custom Cooking Island provides an impressive working surface and features high-quality aluminum and steel construction with solid stainless door pulls, a heavy-duty sliding shelf, paper towel rack, ample storage cabinets for charcoal and utensils, locking casters, a durable, weather resistant powder coated finish and comes with a lifetime warranty!

76 in / 1.9 m Cooking Island for Large – 116352
76 in / 1.9 m Cooking Island for XLarge – 116369



76 in / 1.9 m
Cooking Island



60 in / 1.5 m
Cooking Island



The 60 in / 1.5 m Custom Cooking Island fits smaller spaces yet offers the convenience of a heavy-duty sliding shelf and features the same high-quality aluminum and steel construction as the larger version.

60 in / 1.5 m Cooking Island for Large – 116338
60 in / 1.5 m Cooking Island for XLarge – 116345



- **XLarge Dimensions:**
61 in L x 32 in W x 31 in H
1.6 m L x .8 m W x .8 m H
- **Large Dimensions:**
60 in L x 25 in W x 31 in H
1.5 m L x .6 m W x .8 m H



Acacia hardwood table tops feature an attractive Big Green Egg logo

Acacia Hardwood Tables

Fashioned from exotic woods grown in ecologically sustainable forests, Big Green Egg's solid acacia tables are handcrafted to the highest quality standards and offer ample and convenient working and serving area. Each table is a durable and unique work of art so beautiful that you'll want to use them indoors!

Solid Acacia Table for Large – 118257
Solid Acacia Table for XLarge – 118264

Table Nest

The metal Table Nest, which provides air flow beneath the EGG, is an optional component for all Big Green Egg tables. The Table Nest is also useful for custom outdoor kitchens.

Please note that the Table Nest is not designed for free-standing applications unless the EGG is housed within a Table, Island or built-in surround.

- Table Nest for XXL – 115638
- Table Nest for XL – 113238
- Table Nest for L – 113214
- Table Nest for M – 113221



XXL Table Nest

See Safety Tips at BigGreenEgg.com. Do Not Place EGG directly on wood or combustible surface!
Table Nest must be used in conjunction with a table. Not for use as a free-standing support for your EGG.

NESTS, EGG MATES AND HANDLERS

Nests® and Carriers

The Big Green Egg Nests are designed to raise your EGG to a comfortable cooking height while allowing for easy mobility. Nests are made of durable powder-coated steel. XXLarge, XLarge, Large, Medium and Small Nests include two locking casters.

- Nest for XXLarge EGG – 114723
- Nest for XLarge EGG – 301079
- Nest for Large EGG – 301000
- Nest for Medium EGG – 302007
- Nest for Small EGG – 301062
- Carrier for Mini EGG – 116451

The MiniMax EGG comes complete with its own transportation in the form of a sturdy, easy to grip Carrier.



Portable Nest for MiniMax EGG

The Portable Nest for the MiniMax is designed to raise this portable EGG to a comfortable cooking height – perfect for camping, tailgating or wherever your next pop-up event happens. The Portable Nest conveniently folds for storage or transporting to events – 120649



Folding EGG Mates®

The Big Green Egg Mates are used with an EGG in a Nest and provide convenient working or serving space. The set of two Mates can be folded down when not in use.

Wooden EGG Mates

EGG Mates for XLarge EGG – 301048

EGG Mates for Large EGG – 301031

EGG Mates for Medium EGG – 301055

EGG Mates for Small EGG – 114563

Durable Composite EGG Mates

Easy to clean composite Mates feature a non-slip textured surface, a wider side profile, subtle wood-grain detailing and attractive BGE logo.

3-Slat Composite Mates

- For XXLarge EGG – 115454
- For XLarge EGG – 115447
- For Large EGG – 115430

2-Slat Composite Mates

- For Medium EGG – 115416



WOODEN

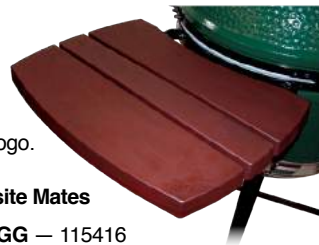

COMPOSITE



EGGmat

Enhance and protect the area around your EGG with the heat and stain-resistant EGGmat. The heat-resistant pad is constructed from eco-friendly recycled materials and features a prominent Big Green Egg logo. Engineered for durability, the EGGmat is stain, fading and mildew-resistant. 30 in x 42 in (76 cm x 107 cm) – 117502



IntEGGrated Nest+Handler

The IntEGGrated Nest+Handler merges two great products (EGG Nest and Nest Handler) for a strong, stable, mobile base for the EGG. Includes 2 locking casters.

- For Large EGG – 120175

Nest Handlers

The Big Green Egg Nest Handlers secure the EGG to the Nest to ensure greater stability and easier handling when rolling. The Handlers are made of durable powder-coated steel.

- For XXLarge EGG – 114730

- For XLarge EGG – 302083

- For Large EGG – 301086

- For Medium EGG – 302076



EGG COVERS

Our Big Green Egg covers are made from a ventilated, heavy-duty material and feature the Big Green Egg logo and coordinating piping. The weatherproof fabric protects against fading from UV rays, and moving the cover off and on is easy with the convenient handle.



Premium Weatherproof Table Covers

For XLarge EGG in a Big Green Egg Wood Table – 117182
For Large EGG in a Big Green Egg Wood Table – 117175



Premium Weatherproof Nest Covers

The Nest covers fit all configurations of the EGG – with or without Mates or Handler.

For XLarge EGG – 117007
For XLarge EGG – 116994
For Large EGG – 116987
For Medium EGG – 116970
For Small EGG – 116963
For MiniMax EGG – 116956
For Mini EGG – 116949



Dome Covers for Modular Nests or Built-In Outdoor Kitchens

For XLarge EGG – 116932
For Large EGG – 116925

Premium Weatherproof Island Covers

For XLarge or Large EGGs in a 76 in / 1.9 m Cooking Island – 117199
For XLarge or Large EGGs in a 60 in / 1.5 m Cooking Island – 116918



KNOW THE HEAT

Digital Thermometers

The digital thermometer is a necessity when cooking meat or poultry to safely monitor the internal temperature.



Quick Read Digital Food Thermometer

Small, convenient digital thermometer fits in your pocket – 101044



Dual Probe Wireless Remote Thermometer

This remote wireless thermometer monitors temperatures from a distance of up to 300ft / 91m. Includes preset temperatures for beef, veal, lamb, pork and poultry ... and nine popular game meats – 116383



Instant Read Digital Food Thermometer

Highest accuracy readout of the internal temperature of foods – 112002



Professional Grade Infrared Cooking Surface Thermometer

Safely measures the temperature of cooking surfaces without contact for precise heat control every time! Aim the precision laser light beam at pizza stones, griddles or cooking grids to instantly see the surface temperature before adding food to the grill. Measures surface temperatures in a range from 32°F to 800°F / 0°C to 427°C – 114839

SMOKING WOODS AND PLANKS



Smoking Wood Chips and Chunks

Wood smoking chips and chunks add a variety of delicious flavors to foods cooked over the coals. Each type of wood will impart a different flavor to meats or other foods, resulting in an endless variety of new flavor combinations.



Apple Chips and Chunks provide a natural sweetness that's mild enough to use with fish, shellfish and poultry – 113962 (Chips), 114617 (Chunks)

Cherry Chips add a mild and slightly fruity flavoring and pair well with game birds and almost any meat including beef tenderloin, pork, poultry and lamb – 113979 (Chips)

Hickory Chips and Chunks enhance any red meat such as brisket or pork shoulder, as well as turkey and chicken – 113986 (Chips), 114624 (Chunks)

Mesquite Chunks add a tangy smoke flavor and are best suited for large cuts of beef such as brisket – 114631 (Chunks)

Pecan Chips add a rich, mellow flavor to chicken and fish, and gives poultry a golden brown skin that enhances any holiday feast – 113993 (Chips)

Jack Daniel's® Barrel Chips are a good choice for flavoring steak, veal, pork and poultry – 017499 (Chips)



Planked Brie with Cranberry Relish

Ingredients

Cranberry Relish

1½ cups (360 ml) granulated sugar
 ½ cup (120 ml) cranberry juice
 ½ tsp (3 ml) freshly grated ginger
 ½ tsp (3 ml) ground cinnamon
 16 oz (450 g) bag fresh cranberries
 Zest of 1 orange (orange part only)

Brie

1 5-in (13 cm) wheel of Brie
 1 orange, sliced into thin rounds
 1 Western Cedar Grilling Plank
 White wine for soaking the plank

Method

Set the EGG for direct cooking without the convEGGtor at 375°F/190°C.

to the syrup and cook just until they begin to pop, about 2-3 minutes. Skim the foam off the surface with a metal spoon and discard. Remove from heat, stir in orange zest and cool to room temperature, uncovered. Cover and store in the fridge for up to 3 months.

Brie

Soak the cedar plank in white wine and water for 30 minutes. Place the plank logo-side down for 3 minutes. Flip the plank; place the orange rounds on the plank then add the brie on top. Smoke for 15-18 minutes, remove from the EGG and top with ½ cup (120 ml) Cranberry Relish. Serve with crackers or toasted crostini.

Cranberry Relish

In a Cast Iron Skillet, add sugar, juice and spices. Cook, stirring often, until sugar dissolves, syrup is clear and comes to a rolling boil. Add cranberries

Gourmet Grilling Planks

Plank cooking is a unique culinary method which originated with the Native Americans, and has evolved into a popular at-home cooking technique that adds a new dimension of flavor to your grilling experience. Our planks come from certified sustainable wood sources; two planks per package. 5 in x 11 in (13 cm x 28 cm)

Western Red Cedar Grilling Planks

offer a robust, woody flavor to fish, beef and other grilling favorites – 116307

Northwest Alder Grilling Planks

impart a subtle, smoky finish to fish, chicken and vegetables – 116291



Scan to view the Big Green Egg Plank Cooking Publication

CERAMIC EGGCESSORIES

The Big Green Egg Pizza & Baking Stone is a versatile piece of cookware for baking a variety of recipes from pizzas to breads to desserts. The stone distributes heat for even baking and browning, and the ceramics pull moisture from the outer surface of the dough for brick-oven crustiness. The stone also retains heat, so foods remain warm longer.



The convEGGtor®



The convEGGtor is designed to facilitate indirect cooking on the Big Green Egg by providing a heat-directing barrier between the food and the charcoal, transforming your EGG into an outdoor convection oven. The design of the convEGGtor, in conjunction with the thermal properties of the EGG, allows heat to efficiently radiate within the dome and prevents the direct flames from reaching the food.

For XXLarge EGG – 114419
 For XLarge EGG – 401052
 For Large EGG – 401021
 For Medium EGG – 401038
 For Small EGG – 401045
 For MiniMax EGG – 116604
 For Mini EGG – 114341



Ceramic Pizza & Baking Stones

Pizza & Baking Stones
 Fits XXLarge and XLarge EGGs
 Diameter 21 in / 53 cm – 401274

Fits XXLarge, XLarge and Large EGGs
 Diameter 14 in / 36 cm – 401014

Fits XXLarge, XLarge, Large, Medium, Small and MiniMax EGGs
 Diameter 12 in / 30 cm – 401007



Deep Dish Pizza & Baking Stone
 Ideally suited for baking pizza, pies, quiche ... even brownies or cinnamon rolls.

Fits XXLarge, XLarge and Large EGGs
 Diameter 14 in x 2 in depth (36 cm x 5 cm)
 – 112750

The Pizza & Baking Stone turns your EGG into a fire-brick oven, perfect for making pizzas, breads, desserts and other baked items.

With the Half Moon Baking Stone, you can cook indirect on one half of the cooking grid, while keeping the other half of the grid available for roasting meats or vegetables.

Half Moon Baking Stones
 Fits XXLarge and XLarge EGGs
 Diameter 21 in / 53 cm – 002389

Fits XXLarge, XLarge and Large EGGs
 Diameter 16 in / 41 cm – 002396

PIZZA AND BAKING TOOLS

With the Big Green Egg and our pizza EGGcessories, you can easily bake your own international specialties ... custom flatbreads, pizzas, calzones, tortillas or naan.



Dough Rolling Mat

Easily roll out and perfectly form pizza, calzone or bread dough at home just like a professional pizzaiolo! Our flexible silicone mat provides a large, slip-proof surface with guidelines for making five sizes of crust. The mat is also perfect for rolling pie crusts, cookie dough or other pastries. Easy recipe included on mat – 114167



Gather your favorite ingredients and toppings – along with your family and friends – and enjoy creative, hot-off-the-EGG homemade meals!



Calzone Press

Spice up your next pizza night! Use a Calzone Press to create custom calzones and filled pastries at home with everyone's favorite ingredients. Works well with your favorite pizza or pie dough. Easy recipe included.

Family Size Calzone Press – 114181

Personal Size Calzone Press – 114174



Aluminum Pizza Peel

Features a smooth and sturdy aluminum surface with a comfortable Soft Grip handle. Keeps hands away from the heat and provides a convenient way to handle pizza, calzones and bread – 118967





Rustic Peach and Thyme Galette with Almonds and Honey Yogurt

Recipe adapted from **Dishing Up the Dirt: Simple Recipes for Cooking Through the Seasons**, published by HarperCollins Publishers.

Ingredients

1½ lbs (680 g) small ripe peaches, peels left on, quartered and pitted
 ¼ cup + 4 tbsp (120 ml) honey, divided
 ⅓ cup (160 ml) almonds
 1 cup (240 ml) all-purpose flour
 ¼ cup (60 ml) sugar
 ½ tsp (3 ml) fine sea salt
 7 tbsp (105 ml) chilled, unsalted butter cut into ½ in chunks
 1 egg, separated
 3 tbsp (45 ml) fresh thyme leaves
 1½ cups (360 ml) plain yogurt

Method

Set the EGG for indirect cooking with the convEGGtor at 400°F/204°C.

Prepare the filling: Cut three sheets of parchment paper slightly smaller than the size of a Baking Stone and lay one on the stone. Arrange the peaches, skin side down, on the parchment; drizzle with honey. Roast until the peaches are tender and beginning to brown, about 20 minutes. Flip the peaches, then continue roasting until they are very tender, about 12 more minutes. Set the Baking Stone and the peaches aside to cool.

Make the crust: Coarsely chop the almonds in a food processor; transfer to a bowl. Add the flour, sugar and salt to the processor and pulse a few times. Add the butter and pulse until the mixture resembles a coarse meal. Add the egg yolk and blend until moist clumps form. Gather the dough into a ball and flatten it into a disk. Wrap it in plastic and freeze for at least 30 minutes. Let the dough stand at room temperature for 10 to 15 minutes before rolling out.

Roll out the dough disk in between the two remaining floured sheets of parchment to a 10 inch (25 cm) round. Remove the top sheet of parchment and set it aside. Sprinkle the dough evenly with ½ of the chopped almonds. Replace the parchment atop the crust and roll it to an 11 inch (28 cm) round, embedding the nuts in the dough.

Reduce the temperature of the EGG to 375°F/191°C. Invert the crust and parchment onto a Baking Stone, nut side down. Remove the parchment that is now on top and arrange the peaches over the center, alternating skin up and skin down; leaving a 1½ to 2 inch (4 to 5 cm) border. Using the parchment as an aid, fold the outer edge of the crust over the peaches. Sprinkle the crust with the thyme and 2 tablespoons honey and the remainder of the chopped almonds. Brush the egg white over the crust. Add the Stone to the EGG and bake until the crust is golden brown, about 30 minutes, cool for 20 minutes.

Mix the yogurt and honey. Cut the galette into wedges and serve with the honey yogurt.

The Ultimate Pizza Wheel

Features a durable stainless steel rotary blade for perfect slices and a non-slip grip and integrated blade guard for safety. The cutter disassembles for easy cleaning in the dishwasher – 118974



Pizza Slice Server

Serve up your creations like a pro. The extra-wide stainless steel blade is ideal for easy handling of galettes, pizza, pie, appetizers and more. Oversized soft grip handle for comfort and control – 114143



SPECIALTY COOKWARE

Cast Iron Plancha Griddles

The Dual-Sided Cast Iron Plancha Griddles are ideal for searing meats and seafood, sautéing vegetables and grilling sandwiches. Authentic, high temperature “steak house” grilling is quick, easy and delicious.

Round Plancha Griddles

14 in / 36 cm, fits XXL, XL, L – 117656

10.5 in / 27 cm, fits XXL,
XL, L, M, S, MX – 120137



Half Moon Plancha Griddles

22 in / 56 cm, fits XXL, XL
– 116406

16 in / 41 cm, fits XXL,
XL, L – 104090



Below: the 10.5 in / 27 cm Plancha Griddle (120137) is designed to pair with the 10.5 in / 27 cm Cast Iron Skillet (120144) to form a Dutch oven.



Cast Iron Skillet

Perfect for searing, braising, baking, sautéing or roasting. The pre-seasoned skillet is designed with two easy to grip handles and built to deliver a lifetime of cooking enjoyment!

14 in / 36 cm, fits XXL, XL, L – 118233

10.5 in / 27 cm, fits XXL, XL, L, M, S, MX – 120144



118233



5.5 quart / 5.2 liter
Oval - 117670

4.2 quart / 4 liter
Round - 117045

Enameled Cast Iron Dutch Ovens

The Enameled Cast Iron Dutch Ovens provide excellent heat retention, making them ideal for slow-cooking, braising, roasting, simmering and baking! With lids that double as an additional cook pot, the durable enameled Dutch Ovens are easy to clean, dishwasher safe and heat-resistant to 450°F / 232°C. Fits XXL, XL and L EGGs.



Sausage-Stuffed Onions

Ingredients

8 small onions (a mix of red and white), peeled
1 tbsp (15 ml) olive oil
1¼ lb (570 g) spicy pork sausage
5 cloves garlic, minced, divided
½ tsp (2.5 ml) kosher salt
1 tsp (5 ml) ground black pepper
1 tsp (5 ml) dried oregano
½ tsp (2.5 ml) crushed red pepper
⅓ cup (80 ml) grated Parmigiano Reggiano cheese
¼ cup (60 ml) panko
¼ cup (60 ml) butter, melted
1 cup (240 ml) beef broth
3 shallots, cut into chunks
2 sprigs fresh thyme

Method

Set the EGG for direct cooking at 375°F/191°C.

Add 2 quarts (1.9 L) water to a Dutch oven and place on the cooking grid. When the water comes to a boil, add the onions and cook for about 15 minutes until tender; remove from the water and cool. Cut off the tops and hollow out the onions, leaving 2 outer layers intact. Finely chop ½ cup of the scooped out centers.

In a Cast Iron Skillet, heat the oil. Add the chopped onion and cook until translucent. Add sausage, 2 cloves garlic, salt, ½ tsp black pepper, oregano and red pepper. Cook until browned; remove from the skillet and wipe the skillet with a paper towel. In a bowl, combine the cheese, panko, remaining black pepper and oregano; stir in melted butter.

In the skillet, combine the broth, wine, shallots, remaining garlic and 1 sprig thyme. Spoon the sausage mixture into hollowed-out onions and add to the skillet. Bake for 20 minutes then sprinkle with the panko/cheese mixture. Bake for an additional 20 minutes until the topping is golden brown. Garnish with thyme and serve.





Cast Iron Cooking Grids

For perfect sear marks on your food, utilize the superior heat conductivity of the Cast Iron Cooking Grid. The cast iron gets very hot and retains heat, turning it into a perfect searing surface.

for Large EGG – 100092
 for Medium EGG – 100085
 for Small or MiniMax EGG – 100078
 for Mini EGG – 113870

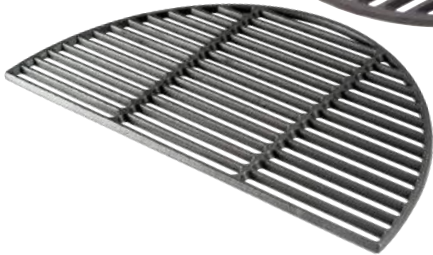

Half Moon Cast Iron Grid for XLarge EGG – 103048



Cast Iron Dutch Oven

The 5.5 quart / 5.2 liter Dutch Oven is ideal for cooking stews, soups, chili and even cobblers. Fits XXLarge, XLarge, Large and Medium EGGs – 117052



Multi-Level Tiered Racks

When you are cooking several different foods at once or when preparing meals for a large crowd, our assortment of multi-level grids increases the amount of cooking space in your EGG.



2 Level Cooking Grid
 Chrome-plated steel base with a porcelain coated grid. Fits XXLarge and XLarge EGGs – 201317

3 Level Cooking Grid

The top levels of the rack rotate and are adjustable to multiple levels. Disassembles for easy storage. Dishwasher safe. Fits Large EGG – 370006



Folding Grill Extender
 Easily attaches to your cooking grid to add a second level of cooking surface in your EGG. The grid folds up to allow for larger dishes, such as roasts or whole chickens and conveniently folds flat for storage. Fits XLarge and Large EGGs – 201126

Raised Grids

The Half Moon Raised Grids with Drip Pan give you the flexibility to cook direct on one half of the EGG and indirect on the other half. The Raised Grids can be paired with an optional Half Moon Baking Stone.

Half Moon Raised Grid with Drip Pan

fits XXLarge and XLarge EGGs – 101082
 fits XXLarge, XLarge and Large EGGs – 101051

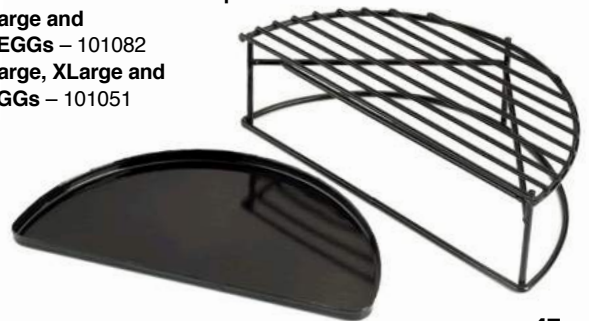



Rib and Roast Racks

Our dual purpose Rib and Roast Racks can be used upright to hold roasts and poultry or can be flipped over to serve as an efficient rib rack.

Anodized Aluminum Roasting & Drip Pans

The Roasting & Drip Pans feature an easy to clean surface and have the Big Green Egg logo embossed in the bottom of the pan. The Rectangular Drip Pan works perfectly with the Rib and Roast Rack for cooking turkey, roasts, chickens and other larger cuts of meat. The Round Drip Pan works well with the Vertical Roasters.

Rectangular Drip Pan

13 in x 9 in / 33 cm x 23 cm,
fits XXLarge, XLarge, Large
and Medium EGGs – 117397

Round Drip Pan

Diameter 9 in / 23 cm, fits XXLarge,
XLarge, Large, Medium, Small
and MiniMax EGGs – 117403



**Stainless Steel
Small Rib and Roast Rack**
Fits XXLarge, XLarge, Large, Medium
and Small EGGs – 117557

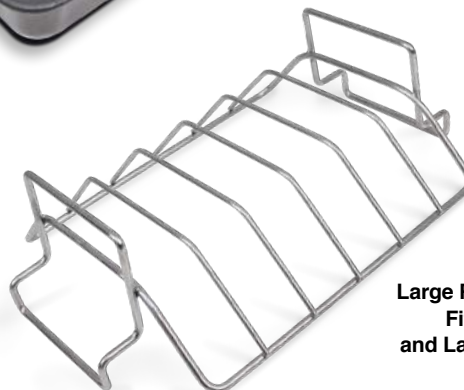

**Stainless Steel
Large Rib and Roast Rack**
Fits XXLarge, XLarge
and Large EGGs – 117564

Perforated Grids

The perforated grids allow heat and flavor to reach the food and make it easy to cook fish or small foods like mushrooms, asparagus, shrimp or scallops that might fall through the standard cooking grids. The half-moon grid leaves half of your cooking space available for direct heat.

Round Perforated Cooking Grids

Diameter 16 in / 41 cm, fits XXLarge, XLarge
and Large EGGs – 201287

Diameter 13 in / 33 cm, fits XXLarge, XLarge, Large,
Medium, Small and MiniMax EGGs – 102010

Half Moon Perforated Cooking Grids

Diameter 23 in / 58 cm, fits XXLarge
and XLarge EGGs – 116390

Diameter 16 in / 41 cm, fits XXLarge,
XLarge and Large EGGs – 106056





Perforated Grill Wok

A Grill Wok makes it easy to cook vegetables, meat, seafood or any other smaller pieces of food that might slip through the standard cooking grids. The Grill Wok allows the heat and smoke to circulate around the foods for even cooking and flavor absorption.

Fits XXLarge, XLarge, Large, Medium, Small and MiniMax EGGs – 002068



Stir-Fry & Paella Grill Pan

This 4 quart / 3.8 liter pan is perfect for creating traditional paella recipes as well as delicious stir-fry meals! Experiment with different meats, poultry, seafood and seasonal vegetables to create your favorite interpretations of these popular international dishes. **Fits XXLarge, XLarge and Large EGGs – 002167**



Mini Burger "Slider" Basket

Holds up to twelve delicious mini-burgers or sliders, which are fun and easy to top with cheese or other creative toppings. **Fits XXLarge, XLarge and Large EGGs – 002105**

Vertical Poultry Roasters

Using a vertical roaster on the EGG will produce the juiciest, most flavorful poultry you've ever tasted! Vertical roasters hold a chicken or turkey upright during cooking for even browning and easier carving when done. The ceramic and folding roasters hold liquid such as fruit juice or beer to add flavor to the poultry.



Folding Stainless Steel Beer Can Chicken Roaster
Fits XXLarge, XLarge, Large, Medium and Small EGGs – 002099

Stainless Steel Vertical Chicken Roaster
Fits XXLarge, XLarge, Large, Medium and Small EGGs – 117458

Stainless Steel Vertical Turkey Roaster
Fits XXLarge, XLarge, Large and Medium EGGs – 117441



Ceramic Vertical Chicken Roaster
Fits XXLarge, XLarge, Large, Medium and Small EGGs – 119612



Vertical Turkey Roaster
Fits XXLarge, XLarge, Large and Medium EGGs – 119629

GRILLING TOOLS



Solid Teak Cutting Board

Made of sustainably harvested plantation teak, the most stable wood for outdoor or wet applications. This board is both beautiful and functional ... built for outdoor use beside the EGG, perfect for carving grilled meats and vegetables, and attractive as a serving board for all of your favorite grilled foods – 120632



All Purpose Cutting Board

Features a drip channel on one side for collecting juices from vegetables and meats, and a flat surface on the reverse side for more cutting space. Non-slip silicone border keeps the board from sliding for easy cutting, slicing and chopping – 117069



Comfort Tie® Grilling and Kitchen Apron

Grill in style with this EGGstra comfortable apron! The comfortable, one-size design features unique Comfort-Tie elastic ties that hold the apron securely in place. Features handy front pockets and an attractive Big Green Egg logo. Neck strap easily adjusts for comfort and height – 117113

Stainless Steel Kitchen Shears

Big Green Egg Kitchen Shears are ideal for a multitude of tasks, from trimming poultry, meats and seafood to cutting pizza and snipping herbs, flowers and vegetables. The shears feature ergonomic, textured handles for a secure grip, and lock for safe storage. Dishwasher safe. 9 in / 23 cm – 120106



100% Cotton All-Purpose Towels

Crafted from top quality waffle-weave cotton, these soft and absorbent towels look great and also make cleaning up a breeze. You'll use these plush, lint-free towels for everything from polishing glassware to barbecue spills. The perfect gift for your favorite EGGhead! Embroidered logo, 3 pack – 116840



EGGmitt® BBQ Glove

The EGGmitt BBQ Glove is made of aramid fibers, also used in aerospace, to form a barrier preventing heat from entering the soft cotton inner layer. Extra long cuff for ultimate protection. The Mitt has silicone on the surface for superior grip and is reversible for the left or right hand – 117090



Super-Flexible, Heat-Resistant Silicone BBQ Mitt

This super-flexible mitt withstands extreme heat up to 450°F/232°C. Features a soft, comfortable lining and an FDA-approved, BPA-free silicone exterior – 117083



**Premium Forged
Stainless Steel Knife Set**

The set of two custom Ergo Chef® knives includes an 8 in / 20 cm Chef Knife and a 3.5 in / 9 cm Paring Knife. Both are fully forged from one piece of high carbon German stainless steel from heel to tip – 113207



**Custom Big Green Egg
Stainless Steel Knife Set**

The set of two high-quality knives includes a 3.5 in / 9 cm Paring Knife and an 8 in / 20 cm Chef Knife. High carbon stainless steel for years of trouble-free performance – 117687

All Natural, Eco-Friendly Bamboo Skewers



These 10 in/25 cm all natural skewers are perfect for grilling and serving kabobs or chunks of chicken, shrimp or vegetables. Each skewer has a Big Green Egg logo on an easy-grip handle. 25 skewers per pack – 117465

Flexible Skewers

Marinating is easy with flexible 100% food-grade stainless steel skewers that allow you to marinate in bags and then transfer to the EGG without handling the food twice. The pointed ends stay cool and allow you to easily turn or remove food from the EGG – 201348



Custom Stainless Steel BBQ Tool Set

Great chefs demand the best tools, and this custom-designed hardworking set offers every grilling enthusiast the ultimate equipment to handle every cookout! Extra long stainless steel shafts keep heat safely at a distance, and contoured handles provide a comfortable and secure grip. Great gift idea too!

Set of Three: BBQ Tong, Grill Spatula and Basting Brush
(includes a replacement Brush head) – 116901

Stainless Steel Grill Spatula – 116888
Stainless Steel Grill Tong – 116871
Stainless Steel Grill Brush – 116895



**Stainless Steel
Measuring Cups**

Set of four heavy-duty stainless steel measuring cups (1 cup, ½ cup, ⅓ cup, ¼ cup). Includes a stainless steel ring for easy storage; dishwasher safe – 119551

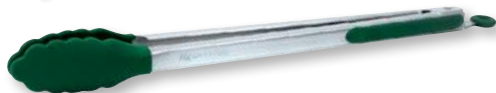

Silicone-Tipped BBQ Tong

These stainless steel BBQ Tong are perfect for turning grilled foods, sautéing vegetables, serving pasta and tossing salads. The silicone-tipped tongs are heat resistant up to 500°F/260°C.

12 inch (30 cm) – 116857
16 inch (40 cm) – 116864

**Professional Grade
Stainless Steel Meat Claws**



These high-quality meat “claws” are designed for easy handling and shredding of larger pieces of meat such as roasts, turkey, chicken and pork. Expertly shred a smoked pork butt into pulled pork sandwiches in minutes for “professional chef” results! High-quality stainless steel with comfort grip handles – 114099



Professional Grade BBQ Tool Set

This 3-piece stainless steel barbecue tool set includes everything you need for your cookout! Stainless steel shafts keep heat safely at a distance, and solid wood handles provide a comfortable and secure grip.

Set of three: BBQ Tong, Grill Spatula and Basting Brush – 117212

GRILLING TOOLS

Barbecue Sauce Mop

Use this all natural, washable cotton Barbecue Sauce Mop to easily add your favorite basting mixtures, flavored butters, glazes and barbecue sauce to anything cooked on an EGG! Removable brush head detaches for easy soaking and cleaning – 114105



Replacement Heads for Barbecue Sauce Mop

Set of two – 114297

Soft-Grip Corn Holders

Genuine Big Green Egg Corn Holders add convenience and a touch of fun every time you grill corn on the cob! High-quality stainless steel prongs and soft-grip handles hold corn securely and keep fingers cool and clean. Corn Holders are designed to nest together for safe storage. Contains 4 pair (8) holders – 117335



Stuff-A-Burger® Press

Stuff burgers with everyone's favorite ingredients – the combinations are endless! Fun and easy to use, the Stuff-A-Burger Press is perfect for any ground meat from juicy beef to mouthwatering chicken, turkey or lamb – makes great stuffed veggie burgers too! Adjustable to two sizes – 114082



Pigtail Food Flipper®

This innovative tool flips everything from a rack of ribs to steaks, tenderloins or chicken. The Pigtail's hook and shaft are made of surgical-grade stainless steel for strength and durability, and the hook will not leave marks in your meat or cause meats to bleed – 201515



Stainless Steel Flavor Injector

Add flavor and juiciness to any roast or poultry! Inject marinades, butter or other flavorings deep into meats to baste and tenderize from the inside out! Includes 2 needles; one for chunky marinades and one for liquids – 119537



Cast Iron Sauce Pot

This heavy-duty, Cast Iron Sauce Pot is perfect for melting butter or warming marinades or barbecue sauce. The no-mess basting brush conveniently nests into the pot handle, and the removable silicone brush head is dishwasher safe for easy cleanup! 2 cups / 480 ml – 117663

Stainless Steel Grill Rings

Now you can grill apples, onions, tomatoes and even artichokes with surprising ease and efficiency. Simply stuff the fruit or vegetable with your favorite seasoning, place on the spike and grill indirect. Set of 3 – 002280





Ash Removal Pan

Although natural lump charcoal produces little ash and requires minimal clean up, the task becomes even easier with the EGG Ash Pan – 106049



Heavy Duty Grid Lifter

The comfort grip Grid Lifter easily and safely grips and lifts stainless and cast iron cooking grids – 117205



V-Notch Grid Cleaner

(Left) The extended handle allows you to clean the grid even when the EGG is hot. The angled design makes cleaning the top and sides of the cooking grid a breeze – 201324



Dual Brush Grill and Pizza Stone Scrubber

Heavy duty, stainless steel mesh scrubber pads outperform wire grill brushes – with no bristles to come loose. The dual brush design works perfectly to easily remove baked-on remnants from your Pizza & Baking Stone – 119476



Grid Gripper

Easily and safely grips and lifts stainless cooking grids and grilling planks – 118370



Stainless Steel Mesh Grill Scrubber

Stainless steel mesh outperforms wire grill brushes and the extra long handle keeps heat safely at a distance. Includes one stainless steel replacement scrubber pad – 119469



Replacement Grill Scrubber Heads

Quick and easy brush replacement; set of two replacement mesh scrubber pads – 119483

Ash Tools

The perfect utensil for removing the small amount of ash that collects in the bottom of the EGG. Using the bar at the end of the Ash Tool, simply pull the ash out of the Draft Door.



Ash Tool for XLarge or XXLarge EGGs – 119490

for Large or Medium EGGs – 119506

for Small, MiniMax or Mini EGGs – 301024

301024

119506

119490

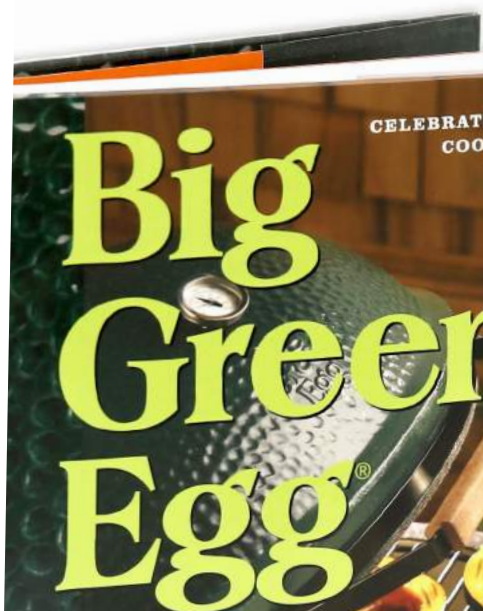

The Big Green Egg Cookbook

The original 320-page, hardcover *Big Green Egg Cookbook* contains extensive color photography and more than 160 delicious recipes that maximize the unique cooking abilities of the EGG. *The Big Green Egg Cookbook* is the perfect inspiration for grilling enthusiasts everywhere ... and the ideal gift for your favorite EGGhead! – 079145



**Ray Lampe's
Big Green Egg Cookbook**

Big Green Egg Ambassador Ray "Dr. BBQ" Lampe has written the ultimate cookbook for EGGheads – packed with more than eighty great recipes covering all the diverse techniques that the versatile EGG can deliver!

Noted for classics like the NFL Gameday Cookbook and BBQ RoadTrip, Dr. BBQ now puts his spin on EGGing with page after page of mouth-watering recipes so appealing you will want to try them all! Makes a great gift for all outdoor cooks – 118073



**The Big Green Egg Book –
Inspiring Recipes from
Around the World!**

Take your cooking on the EGG to the next level with *The Big Green Egg Book*. Coffee table quality, with more than 50 recipes and profiles of 15 international chefs who use the Big Green Egg in their kitchens, this beautiful hard-bound (208 pages) cookbook is bursting with innovative ideas and creative recipes! – 116680

**Big Green Egg
EGGtoberfest® Cookbook**

Favorite recipes from the Big Green Egg EGGtoberfest, an annual event held in Atlanta, Georgia each fall. 112 pages, spiral bound – 000002

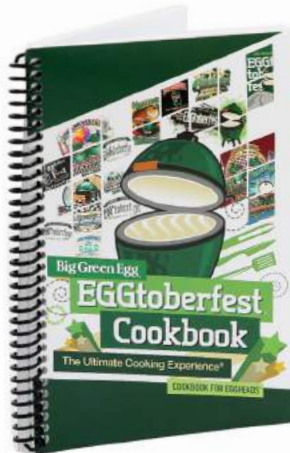

Big Green Egg Tailgate Chair

Relax by your EGG, tailgate in style or enjoy your favorite outdoor sporting event in this super comfortable and durable recreational chair with the official Big Green Egg logo and colors! – 117410



**Mr. EGGhead®
Custom Inflatable**

Turn any Big Green Egg event into a celebration by adding the light-hearted personality of Mr. EGGhead! Sure to produce smiles, this 5 ft (1.5m) character is the perfect host for indoor and outdoor fun, from tailgate parties and community events to an EGGfest® or gathering of friends at your backyard barbecue! The inflatable features an internally-mounted blower for quiet operation; operates on standard 120v household current (US) – 117038

Also available in larger sizes:
12 ft (3.7 m) – 117021
20 ft (6 m) – 117014



BARBECUE SAUCE AND SEASONING

Introducing the NEW line of Big Green Egg Seasonings!

Add flavor to any dish by sprinkling Big Green Egg Seasonings on any of your favorite foods before cooking. For a bolder taste, use the seasonings as a dry rub and apply 30 minutes or longer before cooking, or add them as an ingredient in your favorite recipes.

Gluten-free • No MSG • Kosher

Ancho Chile & Coffee

A robust blend of poblano peppers, coffee and spices

5.5 oz (155 g) – 120557

Citrus & Dill

A tropical blend of citrus, herbs and spices

4.0 oz (113 g) – 120564



Savory Pecan

A nutty blend of sweet and savory flavors
5.3 oz (150 g) – 120571

Sweet & Smoky

Traditional smoked paprika barbecue flavor
5.8 oz (164 g) – 120540



Big Green Egg Barbecue Sauce

Big Green Egg Authentic Smokehouse-Style Barbecue Sauces will enhance the flavor of any barbecue recipe! Four delicious flavors.

Convenient 14 oz / 396 g size!

All Natural • Gluten-free • No MSG

Kansas City Style – Sweet and Smoky – 116529

Carolina Style – Bold and Tangy – 116512

Vidalia Onion Sriracha – 116536

Zesty Mustard Honey – 116505

